

QUARTZ

INSTRUCTION MANUAL

Drum Washing Machine

XQG12-L100824

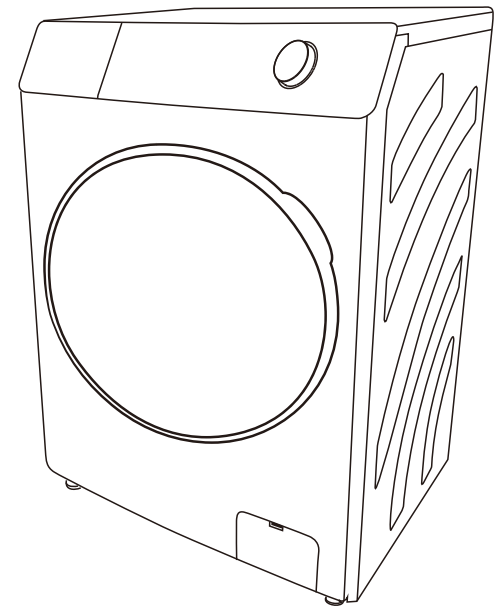

Before operating this washing machine,
please read these instructions carefully
and completely.

CONTENTS

INSTRUCTION BEFORE WASHING

SAFETY NOTICE	2~3
INSTALLATION INSTRUCTIONS	4~6
NAME OF PARTS	7
ACCESSORIES	7

OPERATION INSTRUCTION

SPECIFICATION SHEET	8
LOCK AND UNLOCK METHOD	9
DETERGENT BOX COMPARTMENT INTRODUCTION	9~10
INTRODUCTION TO CONTROL PANEL	11~12
PROGRAM INTRODUCTION	13~14
VARIOUS FUNCTIONS	15~16

CARE AND MAINTENANCE

CLEANING AND MAINTENANCE	17~18
NON-FAILURE CONDITION	19
TROUBLESHOOTING GUIDE	20



SAFETY NOTICE



- **NOTICE:** This appliance can not be used by children aged 8 years and below.







⚠ WARNINGS

Please read this manual carefully before using your machine.

- The precautions stated here are classified as "Warning" and "Attention" according to the damage and the emergency caused by misoperation, and are described respectively in line with the marks below.

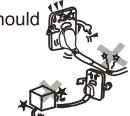
 Warning	Failure to comply could lead to injury or risk of death.
 Attention	Failure to comply could lead to injury or damage to the appliance.

		
This mark indicates warning or attention.	This mark indicates prohibited action.	This mark indicates compulsory action to be carried out.

⚠ Warning	
<ul style="list-style-type: none"> ● Repair operations should only be carried out by professional technicians. Avoid tampering to avert electric shock. 	<ul style="list-style-type: none"> ● The machine is equipped with a bielectrode grounding electric wire socket. Use a creepage protector if possible. 
<ul style="list-style-type: none"> ● Power plug must be unplugged with dry hands. This may cause electric shock otherwise. 	<ul style="list-style-type: none"> ● Please use a dedicated power outlet to plugin the machine. Do not share the outlet with other appliances.
<ul style="list-style-type: none"> ● Damaged, loose wire or plug should not be used. ● Do not damage, alter, forcibly bend, pull, twist or put weight on the wire. 	<ul style="list-style-type: none"> ● Thoroughly wipe the power plug when dirt adheres to the prongs.
<ul style="list-style-type: none"> ● Do not put water in direct contact with the unit during maintenance and repair. This may cause short circuit or electric shock. 	<ul style="list-style-type: none"> ● Washing machine should not be installed in humid place or in places exposed to wind and rain. 
<ul style="list-style-type: none"> ● Do not put fabrics stained with gasoline, benzine, alcohol or paint thinner into or near the washing machine. 	<ul style="list-style-type: none"> ● Keep open flame away from the machine. Failure to do so may result in permanent damage to the machine. ● Do not operate the machine if there is a gas leak. 

⚠ WARNINGS

- Keep children away from the washing machine.

This appliance is not intended for use by persons (including children) with reduced physical, sensory or mental capabilities, or lack of experience and knowledge, unless they have been given supervision or instruction concerning use of the appliance by a person responsible for their safety.



Prohibited

- Do not touch the door when the machine is operating as it might get hot during a high-temperature wash.

- Wait for the door to unlock automatically before opening it. Forcibly opening the door will damage the lock.

- Keep packaging materials away from children.



Prohibited

⚠ Attention

- Do not pull the wire from the socket when unplugging the unit.

Electric cord will get damaged overtime.



Prohibited



- Please unplug the unit when not using it for an extended period of time. Electric shock or leakage may occur due to deformation of plastic parts of the unit.



- Electricity supply must be unplugged with dry hands during maintenance and repair.

- If the power cord or supply cord is damaged, the manufacturer or its service agent or similarly qualified person must replace it in order to avoid a hazard.

- Hot inlet water should not be used for washing.

Electric shock or leakage may occur due to deformation of plastic parts of the unit.



Prohibited

- Do not wash, rinse or spin waterproof fabric or clothing.

May cause abnormal vibration during spinning resulting in damage to the appliance.

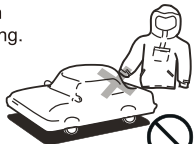

Prohibited

- Do not stand on or put weight on the top of the unit.

Deformation or damage may result to the appliance.



Prohibited

- Two people are required in moving or transportation.

- Keep hands and feet away from the bottom of the washing machine when it is in operation.

Parts working under the product may cause injuries.



Prohibited



Water supply hose should be tightly screwed to the unit.

Failure to do so may result in water leakage. Please check it periodically as it might get loose overtime.

Water leakage

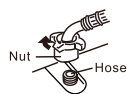

- Check for loose water supply hose connection before washing to prevent damage caused by water leakage.



Water leakage

- The new hose-set supplied with the machine should replace the old hose-set if it is installed.

- Do not block the ventilation openings on the bottom of washer by carpeting when the washer is installed on a carpeted floor.

- Please turn off the water tap when not using the unit.

To prevent damages caused by water leakage.



INSTALLATION INSTRUCTIONS

Transportation

Two people are required in moving the unit. One person on each side should carry the machine by holding the machine's feet.

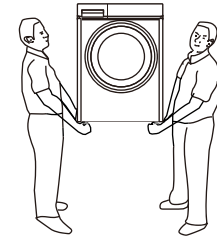

Washing machine must be installed on a ground which must be hard, flat and skidproof. Do not lay the machine on a carpet or wooden floor. Do not put the machine on a platform.

Location of washer

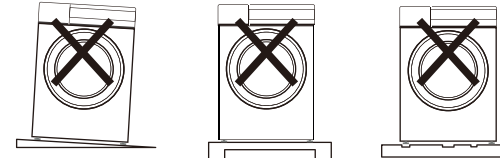

1. On a sloped ground

2. On a platform.

3. On an uneven ground.

Remove the bolt used to fix the drum during transportation.

To protect the machine during transportation, there are 4 bolts inserted into the back of the machine. Remove these bolts before use. Failure to do so will result in a strong vibration during spin and can damage the washing machine invalidating your warranty.

- Unscrew all four bolts by a spanner.
- Remove the bolts and the corresponding spacers.
- Close off the holes using the supplied plastic plugs.

Keep all the parts in a safe place; they will be needed again if the washing machine is moved to another location. Please make sure that the base protection device (shown in the picture) is removed before use.

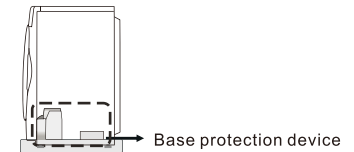
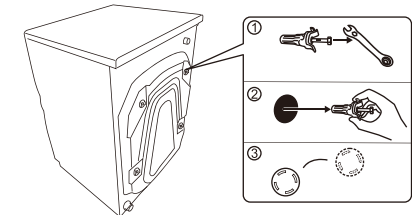

Adjusting the machine's legs.

There will be a strong vibration if the washing machine is not on level ground. Please level the machine by following these steps.

- Check whether the machine is on a level surface using a plumb-line as shown in the figure.
 - The machine is on a level ground if the frame line of the machine is parallel with the plumb-line.
- Adjust the adjustable leg of the machine if necessary to make it level.
- Shake the machine slightly to make sure that it is steady.

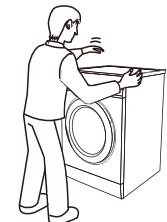
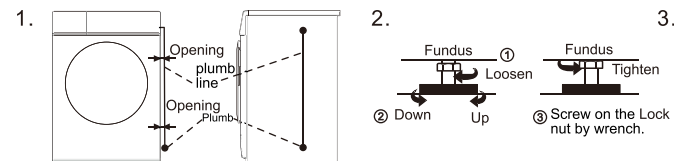

INSTALLATION INSTRUCTIONS

Connecting the Supply Hose

1. Check that sealing washers are firmly seated.
2. Attach the curved end of the hose to the inlet valve of the washing machine. Tighten the coupling nuts securely by hand.
3. Attach straight end of the hose to the tap. Tighten the coupling nuts securely by hand.
4. Turn on the taps and check for leaks. Tighten the coupling nuts firmly if there is any leakage. If water pressure is strong, close the water tap completely then open it slightly.

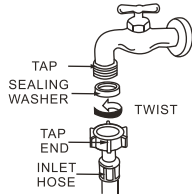

CAUTIONS:

- Do not use water which is hotter than 50°C.
- If your faucet is not suitable, please consult your dealer.

Installing Water Supply Hose to the Washer

While holding the hose turn the nut clockwise till it fits tight.

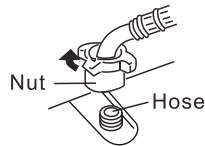

Turn the nut counterclockwise after turning the faucet off when you want to detach the water supply hose.

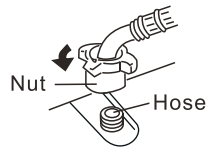

INSTALLATION INSTRUCTIONS

CONNECTION OF DRAIN HOSE

1. When not in use, put drain hose at the back of the washing machine. (pic 1)
2. When in use, rest the drain hose on the side of a wash basin or a bath tub (pic 2). Alternatively, you can connect the drain hose to drain duct piping.

3. Clean the pump filter periodically to keep the drain pump clean of debris.

NOTE: Do not take off the drain hose stay (pic 1) as it is required for proper operation of the machine.

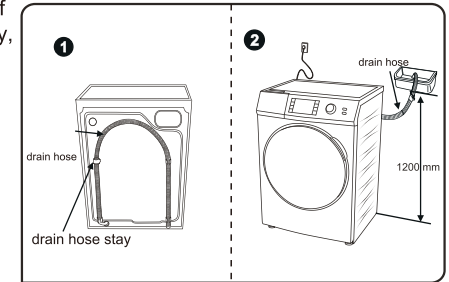

INSTALLATION OF SEALING PLATE

Attention:

1. Please install before removing the transport retaining bolts. Install in at least two persons.
2. Before installing the sealing plate, it is necessary to turn off the faucet and disconnect the power cord from the external power socket, inlet pipe, inlet tap, drain pipe and outlet.

Installation steps are as follows:

1. Remove the sealing plate and remove the double-sided adhesive stickers around the sealing plate.

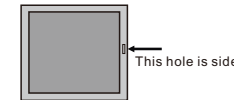

2. Tilt the washing machine back, slowly put down on the cushion, pay attention to the washing machine operating panel should be facing forward.

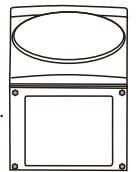

3. Turn the sound-absorbing sponge on the sealing plate towards the inside of the washing machine, position the square hole on the left, and align the screw holes around the sealing plate with those in the washing machine bottom plate. Press around the sealing plate and paste the sealing plate onto the washing machine bottom plate.

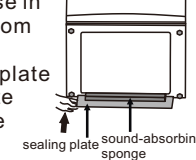

4. Fix the left and right sides and the back of the sealing plate with special screws (large round cap screws). After fixing, gently lift the washing machine and place it smoothly.

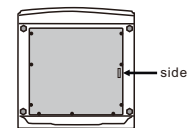

NAME OF PARTS

ATTENTION

- We suggest you run the drum clean program before the first wash.
- Don't forget to close the water tap and to unplug the power plug to avoid any flooding/fire accident.

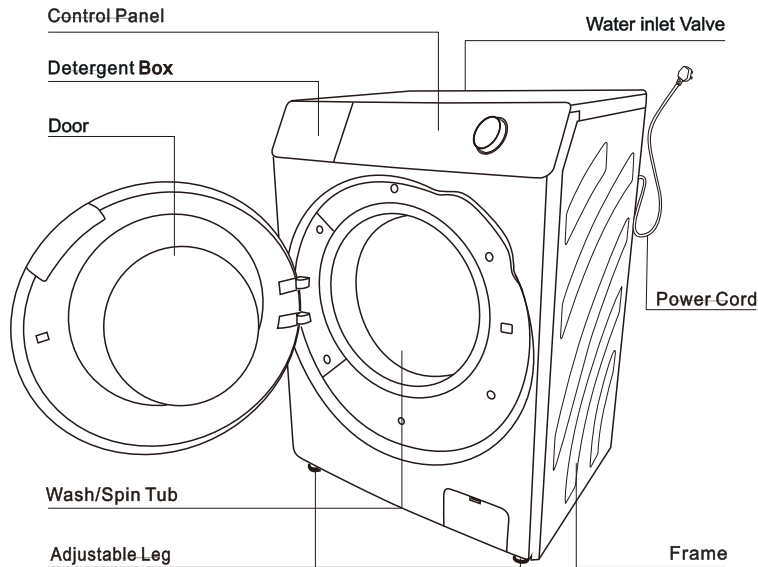

ACCESSORIES

Instruction manual	Water Supply Hose	Lid (4Piece)	Spanner	screw (9Piece)	Sealing Plate

SPECIFICATION SHEET

Rated wash capacity	12kg
Rated spin capacity	12kg
Rated dry capacity	7.0kg
Rated dry power	1500W
Max current	10A
Rated voltage	220V~/50Hz
Rated heating power	1800W
Rated power	2000W
Washing noise	< 50dB
Spin noise	< 69dB
Water consumption	80L
Water pressure	0.03 ~ 1.0MPa
Product dimension	600x635x850

WASHING TIPS

- Check whether there is anything in the pockets (for example: coin, pin, clip, paper, etc).
- Zips shall be zipped close and buttons or hooks shall be fixed. The loose band or ribbon shall be bound together.
- Do not wash colored clothes together.
- Follow the washing guide printed on the clothes' mark or the symbol types of care label by the manufacturer.
- Before first washing, use a white towel dipped in detergents to rub an uneasily discovered place of the clothes for a moment, check whether there is color on the white towel, if the color fades, be careful in washing the clothes.
- If a part of clothes is too dirty, use a towel or soft brush dipped in detergents to rub the dirty part slightly in a same direction. then put the clothes into machine.
- The machine may shock heavily in spin when there is only few clothes or single big and heavy dress, add 2~3 pieces of clothes into the tub to relieve shock.



LOCK AND UNLOCK METHOD

DOOR LOCK

When the machine is working, the door locks automatically. If there is a power failure during a wash cycle, the door will remain locked. Do not try to unlock the door with force, lest you break the lock. Use the emergency door open function to open the door in case of prolonged power outage.

UNLOCK

If you want to unlock the door when the machine is running, you can press the "START/PAUSE" button. The door will not unlock if the drum is hot from high temperature wash. Use a towel to wipe off any spilling froth from the drum.

DETERGENT BOX COMPARTMENT INTRODUCTION

Liquid detergent storage box

- Add liquid detergent through this chamber
- This chamber is a liquid detergent storage box, which can store 700 ml liquid detergent for multiple washing.

washing powder

- This entrance is used for washing powder.
- Insoluble detergent, such as powder soap tablets, please fully dissolve in advance into the detergent box.
- A single dose of liquid detergent can be added.

Softener

- Please put in before washing, will be automatically injected during the last rinse.
- Use concentrated softening agent, please dilute with the appropriate proportion of water and pour.
- Do not exceed the "MAX" mark

How to open the detergent box

- ① ● Pull out the detergent box in the direction of arrow. To the largest, add washing powder.

How to open the liquid detergent storage box

- ② ● Open the lid of the liquid detergent storage box to add liquid detergent according to the instructions of arrow.

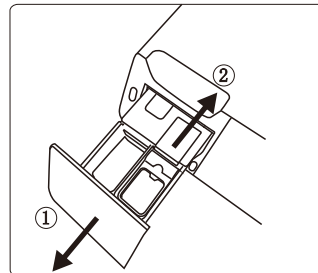

DETERGENT BOX COMPARTMENT INTRODUCTION

Laundry powder compartment notes

- Use roller specific detergent, do not use corrosive and gaseous bleach.
- Do not use excessive detergent, otherwise it will produce too much foam, affect the washing effect, or may cause functional failure.
- Please refer to the manufacturer's instructions and use the detergent according to the species, color, temperature, degree of stain, etc.
- The use of an appropriate amount of detergent, can achieve good washing effect, and conducive to environmental protection.
- Washing powder in detergent box for washing powder and powder additives or single liquid detergent.
- Please place appropriate amount of washing powder when washing, do not place too much, otherwise there will be residue on the door sea.

Notes for use of liquid detergent storage box

- Liquid detergent storage box should only be used for liquid detergent delivery and the solution should not exceed the MAX scale when using liquid detergent to avoid overflow.
- The liquid detergent storage box must be fully inserted before washing or the machine will produce an alarm.
- Do not use corrosive and gaseous bleach.
- Do not turn the liquid detergent storage box upside down in case of liquid detergent overflow from the outlet.
- Do not press the side outlet when moving the liquid detergent storage box to avoid leakage of liquid detergent. Be careful not to spill liquid detergent.
- If less liquid detergent is used, it can also be placed in the washing powder compartment, but not mixed.
- The maximum storage capacity of liquid detergent storage box is 700ml each time. After filling, the user does not need to add it again in each washing
- When ADS function is enabled, users no longer need to add detergent to the detergent box.

INTRODUCTION TO THE CONTROL PANEL

Layout

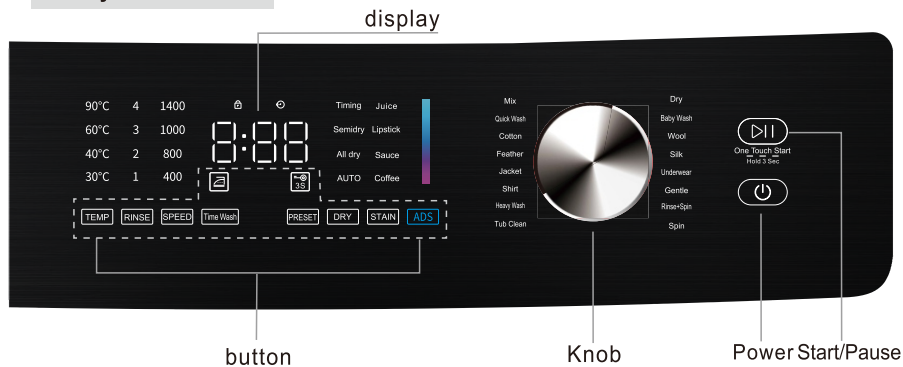

■ START/PAUSE button

- Press the start button to start a wash cycle, press it again to pause it.



■ Power button

- Powers the machine on and off.



■ Display window introduction

- Before washing begins, it will display the remaining time, the water temperature level, spin speed, and other related information.
- In case of a malfunction, it will display the error code.

■ TEMP. button

- Set the washing temperature according to the cloth type.
- The temperature setting range differs from program to program. Some programs do not permit change.

INTRODUCTION TO THE CONTROL PANEL

■ Speed button

- Press to modify or exclude the spin speed; the value selected will appear on the display.
- Some programs may limit the top speed you can set.

■ PRESET Start

- Press to set a delayed start for the selected wash cycle; the set delay time will appear on the display.

■ Anti-Wrinkle Button



- Set the function as required; some programs cannot use this function.

■ Rinse button

- Press this to set the number of times you want to rinse.
- Some programs might not allow changing this value.

■ Dry Button

- Set the drying type and drying time as required.
- Select the drying function by pressing this button.

■ Stains button

- Used to set the type of stain. The washing cycle will be customized accordingly.

■ Time Wash Button

- Complete laundry process. Laundry time can be convenient to choose multiple files, easy to operate.

■ ADS Button

- Turn on or off the ADS automatic release function as required, and the indicator light will be on when it is turned on.

■ Child Lock Button



- long press for 3 seconds to set the child lock function.

PROGRAM INTRODUCTION

Mix	Mix Wash of cotton and synthetics clothes.
Quick Wash	Quick wash of small quantity or light dirty clothes.
Cotton	Wash cotton clothes.
Feather	Suitable for machine-washable feather clothes.
Jacket	Wash jacket clothes.
Shirt	Wash shirt clothes.
Heavy Wash	Wash large clothes.
Tub Clean	Only for cleaning drum, don't add clothes inside drum.
Dry	Dry wet cotton clothes.
Baby Wash	Wash baby clothes.
Underwear	Wash lingerie and underwear clothes.
Silk	Wash silk clothes.
Wool	Suitable for machine-washable wool clothes.
Gentle	Wash delicate clothes.
Rinse+Spin	Only rinse and spin clothes.
Spin	Only spin clothes.

PROGRAM INTRODUCTION

Method for daily laundry

1. Prepare for washing.
 - Put clothes inside drum, close the door.
 - Put detergent or washing powder into the detergent box. If ADS function is used, sufficient amount of detergent should be ensured in the liquid detergent storage box.
 - Open water tap, put the drain hose in right position, plug in the power cord.
2. Press the power button to turn on the machine.
3. Use the knob to select suitable program as required.
4. Press other function buttons to customize washing cycle as required.
5. Press "Start/Pause" button to start the washing.
6. The buzzer sounds after the washing is finished.

Instructions of Wool program

- Turn on the power, select "Wool" program.
- Before washing, check the label on clothes to confirm if it's suitable for washing by machine.
- When the washing is finished, please take out the clothes immediately to avoid wrinkle.
- The water temperature should not be set more than 40°C.
- The use of special detergent for wool can reduce the damage of clothes and improve the washing effect.
- Wash light color and dark color clothes separately.

VARIOUS FUNCTIONS

ADD-UP FUNCTION

- Use this function to add clothing while a wash cycle is already running.
- Press "START/PAUSE" button and wait till the lock light is off. Door lock will be released and the display will show "Add".
- Add clothing, close the door and press "START/PAUSE" button to resume the wash cycle.
- Please don't forcibly open the door, as it will damage the lock.
- If there is a lot of foam or water in the drum, use a dry towel to prevent water from spilling out when opening the door.

CHILD PROTECTION FUNCTION

After close the door and before start washing, if the door is opened twice, the machine will start this function: after the product start, the door is locked, motor will work a short time then stop, door is unlocked. After a while, the door is locked again and product continue to work.

ANTI-WRINKLE FUNCTION

- Scatters the clothes for an additional 8 hours after a wash cycle completes.
- Press the "anti-wrinkle" button after selecting a program to switch it on.
- Press the power button to stop the anti-wrinkle program when it's running.

INSTRUCTION OF PRESET FUNCTION

- Method:
- Turn on power and select required program, press other buttons to customize the washing cycle. Press "PRESET" button to set ending time, then press "Start/Pause" button to start this function. (The preset time is set at 1 hour intervals and can be set up to 24 hours.)
- Caution:
- If you want to change the preset, please press "Power" button to restart it.
 - Press "PRESET" for 3 seconds or turn off power to cancel it.
 - Press "PRESET" to confirm your operation.
 - The real time might be different with preset time because of water pressure, water drain, clothes type, water temperature, etc.
 - Some programs cannot use this function.

CANCELLING THE END BUZZER

- Press and hold the "START/PAUSE" button till you hear the buzzer. The buzzer will be cancelled.
- To restore the buzzer, follow the same step as above.

CHILD LOCK FUNCTION

In order to prevent children from accidentally operating the washing machine while it is working, a child lock can be set so that the door cannot be opened and the keys (except the power button) are locked. The door can be opened after the child lock is released.

Method: Turn on power, press "child lock" button for 3 seconds till the buzzer sounds, this function is set. Repeat the operation will cancel this function.

STAIN FUNCTION

According to stains type on clothes, you can select a special stain function to improve the washing effect. Method: turn on power and select required program, press "STAIN" button to select Juice/Lipstick/Sauce/Coffee. Some programs are limited to select these types. (Washing performance would be different because of different detergent.)

INSTRUCTION OF DRY FUNCTION

- Method:
- Turn on power and select required program, press "DRY" button.
- Timing: Dry clothes in a specified time period.
- Semidry: Keep clothes in a proper humidity after drying for good ironing.
- All Dry: After drying, clothes are dry enough to be stored directly.
- Auto: Use this procedure to dry moist cotton clothes and it will stop when clothes dry.
- Press "Start/Pause" button to start washing and drying.
- Caution:
- Water tap must be opened during dry operation.
 - If select "Timing" dry, you should set a shorter drying time in order to avoid wrinkles on clothes because of too long time drying. You can add drying time as you required.
 - If select "Timing" dry, you should run the spin program at first.
 - If necessary, untie the knots of the clothes after spin operation, then start the dry.
 - Large and thick clothes may be unevenly dried, so please add more drying time depends on drying effect.
 - Only "Timing" dry can be paused during process.

VARIOUS FUNCTIONS

DESCRIPTION OF ADS FUNCTION

How to add detergent and softener

Figure 1: Pull out detergent box, liquid detergent storage box

laundry powder box (Only used when ADS automatic placement is cancelled)

Fabric softeners box

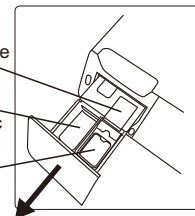
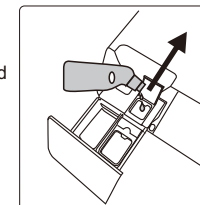

Figure 2: Open liquid detergent, storage box lid, add detergent, liquid level should not exceed MAX limit line.



When to add detergent

When to add detergent: ADS color light with gradual change is normally on after startup; After the program is run, ADS color lamp band is in the state of scroll up and down, indicating that intelligent detection is taking place; After the test, the light blue permanent light belt shows the automatic setting position during the program operation. If "ADS" light with orange flicker shows "U2" on the display screen, it indicates that detergent is insufficient and should be added in time.

How to use ADS function (please refer to the actual interface below)



Step 4: Set the remaining parameters. Set the remaining parameters through various functions and parameter keys.

Step 3: Select the auto release function and press the "ADS" button to select detergent, automatic release function.

Step 1: Press "Power on/off" to start the power supply.

Step 2, select the program, through the knob, select the appropriate program.

Note

Before installing, moving, handling or repairing the washing machine, be sure to draw out the liquid detergent storage box and place it properly to avoid spilling the detergent. After the washing machine is adjusted, the liquid detergent storage box is installed in place and can be used normally.

CLEANING AND MAINTENANCE

- Please clean your machine periodically to ensure longer life span.
- Make sure you unplug the machine from the power outlet when cleaning it.

MACHINE BODY

- Please use a soft cloth to clean the body after each wash cycle. If there is too much dirt, put some detergent or soap water on the cloth to clean the body.
- Do not directly flush the machine with water.
- Do not use paint thinner, petrol or alcohol to clean the washing machine.

DOOR GASKET

Please use a direct cloth to dry the gasket after each wash cycle.

Leave the door ajar for 15 minutes to let the gasket dry.

CLEANING OF DETERGENT BOXES

In order to prevent the detergent boxes from becoming moldy, please clean the detergent boxes regularly. Press and hold the buckle while pulling out the detergent box. Rinse with water and reinsert.

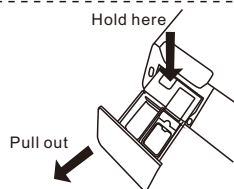

CLEANING OF LIQUID DETERGENT STORAGE BOX

after taking out the storage box, make and clips pop open and then open the lid according to the arrow direction shown in the picture. After cleaning, align the upper cover with the buckle cover, and press and to close the cover tightly.

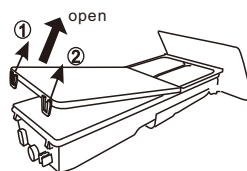

CLEANING THE INLET VALVE (ONCE IN 6 MONTHS)

1. Unscrew the inlet pipe.
2. Take out the filter screen.
3. Use a toothbrush to clean the filter screen and assemble it again.
4. Connect the inlet pipe after cleaning.

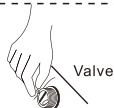

CLEANING THE DRUM (ONCE A MONTH)

Run the drum clean program once a month to clean the inner and external parts of the drum. Put detergent and run the cycle empty without putting any laundry in.

CLEANING AND MAINTENANCE

Machine frozen

1. Use a hot towel to envelop the water tap connector.
2. Disassemble the inlet pipe and put it into 50 degree water.
3. Put one gallon 50 degree water into the tub.
4. Assemble the inlet pipe again; open the water tap and start the machine.

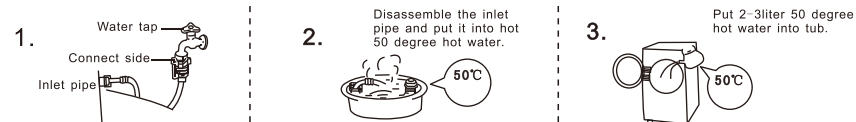

CLEANING THE PUMP FILTER (ONCE A MONTH)

- 1) Make sure the washing machine is done with a wash cycle.
- 2) Press the groove of the pump cover and open it.
- 3) Unscrew the filter anti-clockwise.
- 4) Wash the filter with water and make sure there is no debris inside.
- 5) Screw the filter back clockwise.

Make sure you screw the filter tightly or water will leak. Do not clean the filter when the machine is working.

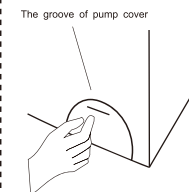

DRAIN RESIDUAL WATER

In case of power failure, drain the laundry container before taking out the clothes.

1. Unplug the washing machine from the power outlet.
2. Pull the flap off the filter with your fingernail or coin.
3. Pull out the black residual drain pipe from the fixed limit.
4. Remove the discharge cap at the front end of the residual water pipe.
5. Let the water flow into the container.
6. Cover the discharge cap and put the residual drain pipe back stuck in the limit.
7. Cover the strainer cover.

Note: Please cool down the cylinder after the water temperature is too high.

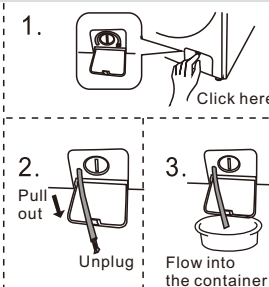

CLEANING OF THE CIRCULATION SPRAY OUTLET

In order to prevent the circulation spray outlet from being blocked by wire scraps and other sundries, please observe whether the circulation spray outlet is blocked before washing. If there is a blockage, it should be cleaned in time.

1. Open the door of the washing machine.
2. Find the circulation spray outlet on the upper part of the sealing ring of the door cover and clean it.

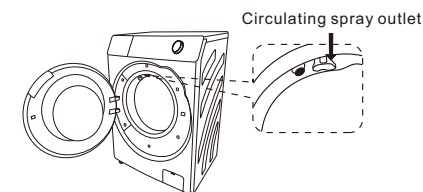

NON-FAILURE CONDITION

SITUATION	REASON
The washer door can not be opened.	<ul style="list-style-type: none"> The washer is in operation Set by the child lock There is clothes caught between the seal ring and the door.
Peculiar smell.	<ul style="list-style-type: none"> Some components are made by rubber, so there may be smell of rubber.
Little water in wash and spin	<ul style="list-style-type: none"> Drum washing machine need only little water to wash clothes.
No water inflow.	<ul style="list-style-type: none"> Whether the faucet is open. Whether the Water Supply Hose be frozen. Whether the Water Supply Hose or the metal filter in water inlet be blocked.
Inflow of water during operation.	<ul style="list-style-type: none"> Water will be supplied automatically when the water level decline. Add clothes during operation.
Drainage water in during washing.	<ul style="list-style-type: none"> Whether there is too much detergents, or detergents with too much bubble.
Remaining time changes	<ul style="list-style-type: none"> If the washing clothes is in uneven distributed, water will be added to balance it. The displayed remaining time is calculated on the basis of 15 liter/minute water intake. As the water pressure will change, actual time will be prolonged or shortened accordingly. If clothes are biased in spin, the spin time will be prolonged to correct the biasing.
Abnormal sound in spin process.	<ul style="list-style-type: none"> Check if power cord contact the machine body. Check if the fixing (bolts) has been removed. Check if there are any barrettes or metal articles inside.
Program stops when power off	<ul style="list-style-type: none"> If power off, the program stops and will not continue when power on, please press the POWER ON/OFF button and re-set the program.
Emergency open door	<ul style="list-style-type: none"> When the power failure for a long time and you want to take out the clothes, unplug the power cord, waiting for the inner drum stop, pull down the emergency rope on the bottom right corner of cabinet, listening a slight noise then you can open the door. (Confirm the water level below the bucket and water temperature below 60°C in advance.)

TROUBLESHOOTING GUIDE

Trouble Indication	Kind Of Trouble	Where To Check	How to resolve the problem
	The washer does not work at all.	<ul style="list-style-type: none"> Check if the Power Cord is securely plugged in. Press the POWER ON/OFF button. Press the START/PAUSE button. Press the START DELAY button. Check whether power failure occurs. Check whether the fuse or circuit breaker has been activated. 	
E11	Water does not flow into the Wash/Spin Tub or water flow is slim.	<ul style="list-style-type: none"> Whether the faucet be opened. Whether the Water Supply Hose be frozen. Whether the Water Supply Hose or the metal filter in water inlet be blocked. Whether the water is out of supply. 	Check and resolve the problem, then press START/PAUSE for one times to restart the washer.
E12	Water does not drain out.	<ul style="list-style-type: none"> Whether drain height too high or not. Whether the Drain Hose is inverted. Whether the Drain Hose is blocked by scrap of fiber. Whether the Drain Hose is too long. 	Check and resolve the problem, then press START/PAUSE for one times to restart the washer.
H	Failure of open the washer door.	<ul style="list-style-type: none"> make sure don't use hot water. Whether the water temperature is high when washing. Whether water level in the drum too high or not 	When the temperature or water level falls to the safe range, it is automatically unlocked.
U1	Detergent box not closed	<ul style="list-style-type: none"> Is detergent box installed in place 	After checking the processing, press the "Start/Pause" key to start the operation.
U2	Low detergent level	<ul style="list-style-type: none"> Check whether the detergent/softener is sufficient in the detergent/softener box 	Add enough detergent
U3	Failure of spin	<ul style="list-style-type: none"> Whether the washing machine be posited steadily. Whether the washing clothes is too big or too heavy. Whether the pieces of clothes for spin is too few. Whether the blanket be rolled into a ball. 	When the clothes is too little, add 2~3 pieces of clothes, then check the machine, Close the door, and press START/PAUSE button for one times to restart the machine.
U4	Door is not closed		Close the door with the "door lock" light on, and then press "START/PAUSE" button, the machine will run.